

DAISY-4X1-W-D

~50° wide beam. Variant with diffused lenses.

TECHNICAL SPECIFICATIONS:

Dimensions	182.0 x 40.0 mm
Height	20.2 mm
Fastening	pin, screw, clips
ROHS compliant	yes 

MATERIAL SPECIFICATIONS:

Component	Type	Material	Colour	Finish
C16992_DAISY-4X1-W-D	Linear lens	PMMA	milky	
C17422_DAISY-4X1-SHD2-MATT	Shade	PC	black	matt
C17423_DAISY-4X1-SHD2-WHT-MATT	Shade	PC	white	matt
C17528_DAISY-4X1-SHD-MET	Shade	PC	metal	gloss
C17535_DAISY-4X1-SHD2-MET-MATT	Shade	PC	metal	matt
C16590_DAISY-4X1-SHD	Shade	PC-ABS	black	gloss
C16784_DAISY-4X1-SHD-WHT	Shade	PC	white	gloss

ORDERING INFORMATION:

Quantities for one set:

Linear lens	1
Shade	1



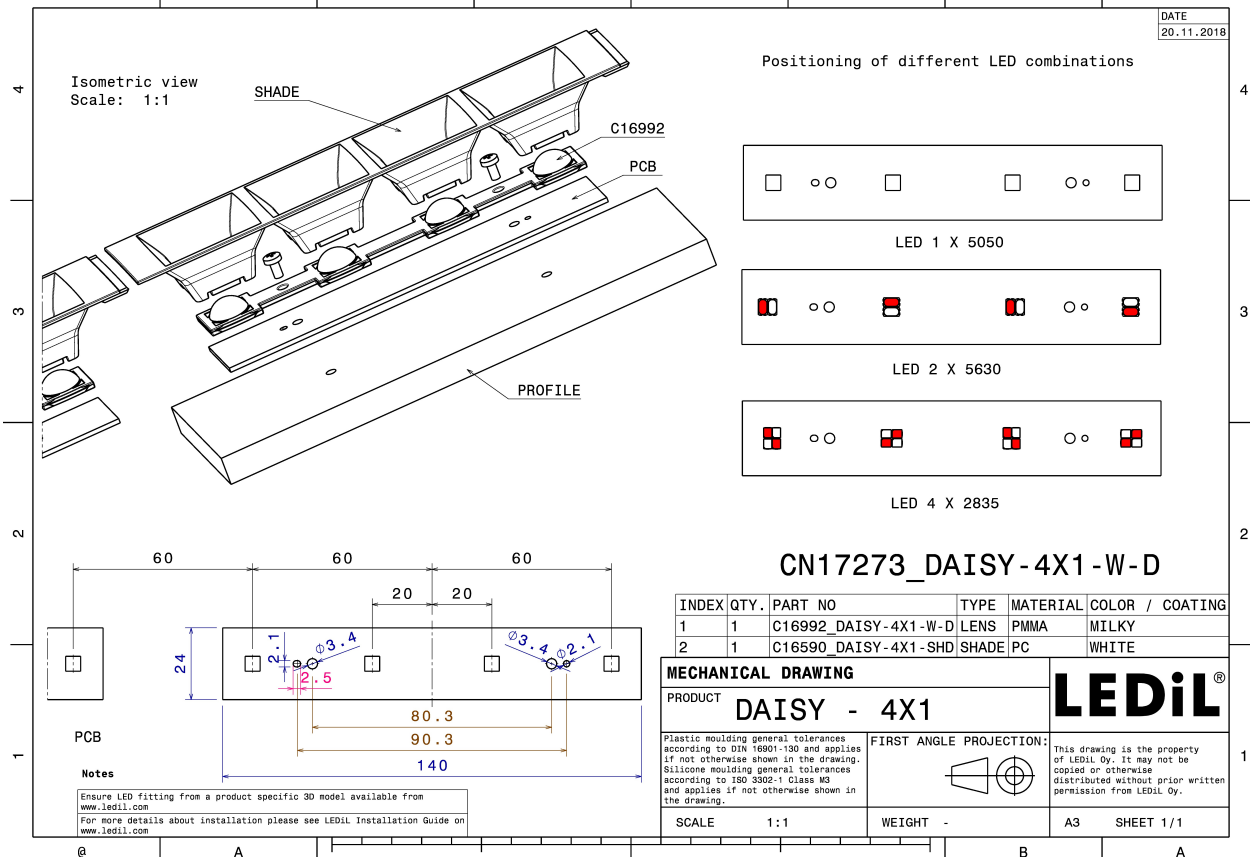
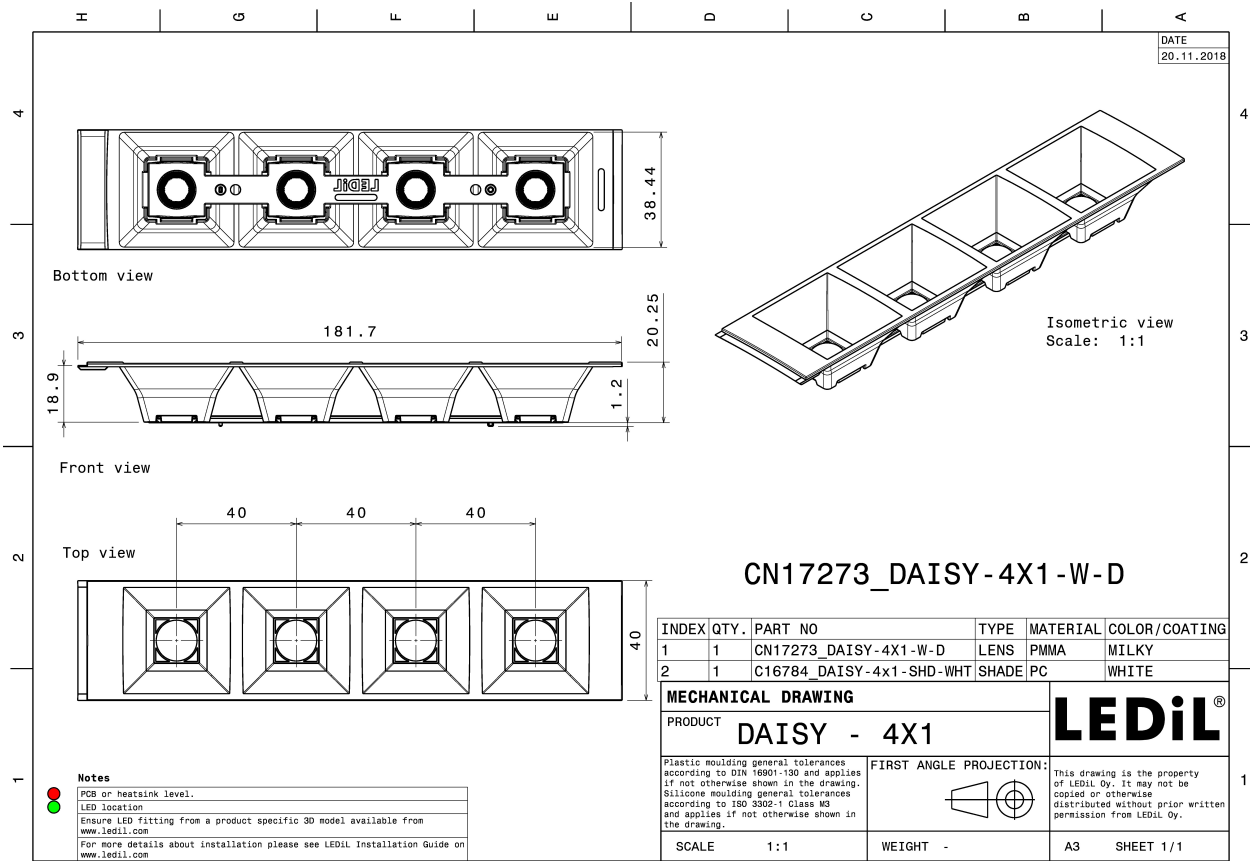

Component		Qty in box	MOQ	MPQ	Box weight (kg)
C16992_DAISY-4X1-W-D » Box size: 480 x 280 x 300 mm	Linear lens	504	336	21	6.3
C17422_DAISY-4X1-SHD2-MATT » Box size: 480 x 280 x 300 mm	Shade	168	336	42	8.2
C16590_DAISY-4X1-SHD » Box size: 480 x 280 x 300 mm	Shade	168	336	42	4.3
C17423_DAISY-4X1-SHD2-WHT-MATT » Box size: 480 x 280 x 300 mm	Shade	168	336	42	4.4
C16784_DAISY-4X1-SHD-WHT » Box size: 480 x 280 x 300 mm	Shade	168	336	42	8.6
C17528_DAISY-4X1-SHD-MET » Box size: 480 x 280 x 300 mm	Shade	168	336	42	4.7
C17535_DAISY-4X1-SHD2-MET-MATT » Box size: 480 x 280 x 300 mm	Shade	168	336	42	4.1

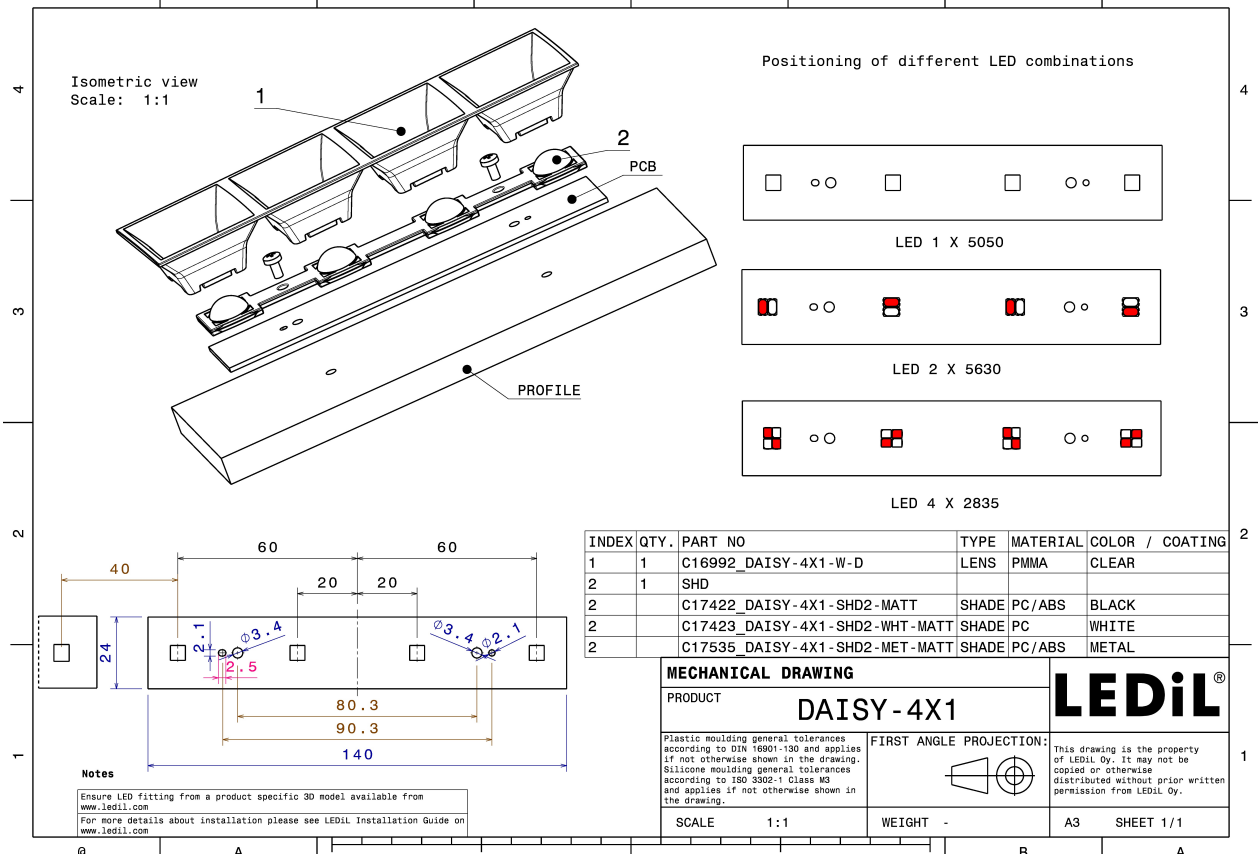
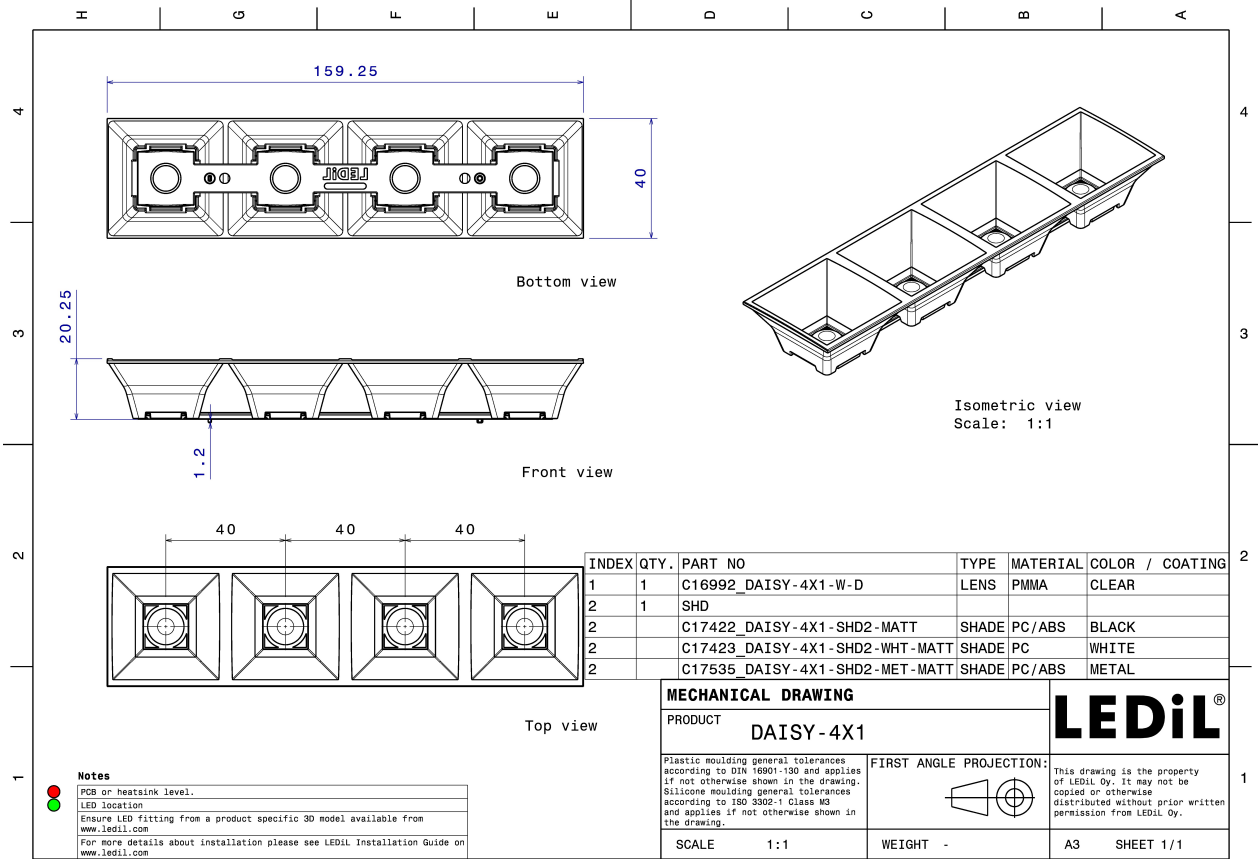

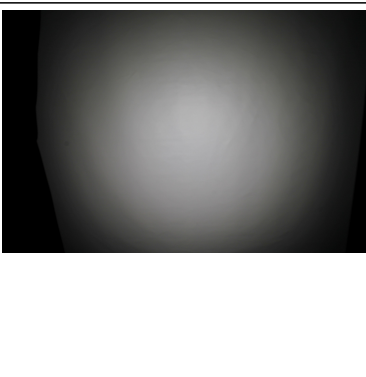
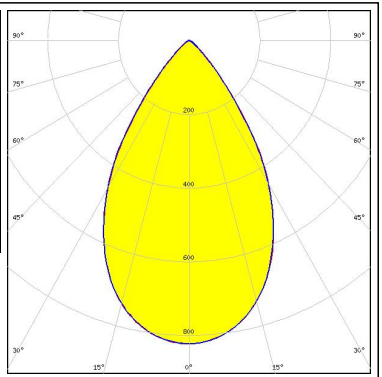
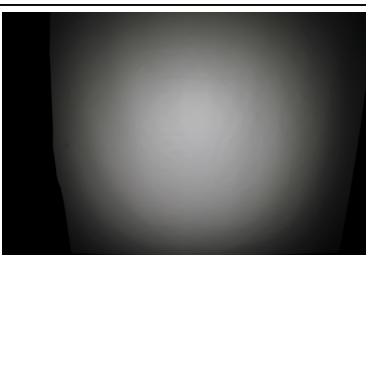
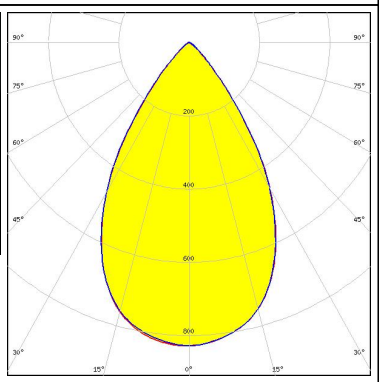

See also our general installation guide: www.ledil.com/installation_guide

PHOTOMETRIC DATA (MEASURED):

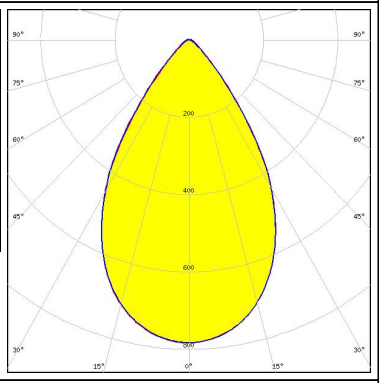
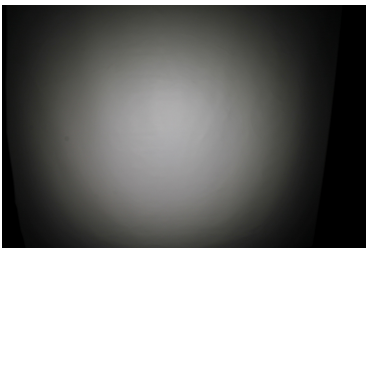
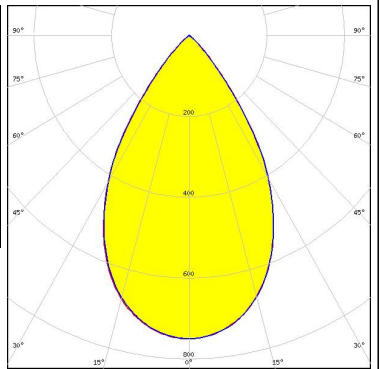
<p>AUDAX ELECTRONICS</p> <p>LED LIGHT ENGINE DAISY 16 LEDs 156mm x 20mm FWHM / FWTM 63.5° / 90.0° Efficiency 88 % Peak intensity 0.8 cd/m LEDs/each optic 4 Light colour White Required components: C17535_DAISSY-4X1-SHD2-MET-MATT</p>		
<p>AUDAX ELECTRONICS</p> <p>LED LIGHT ENGINE DAISY 16 LEDs 156mm x 20mm FWHM / FWTM 63.5° / 90.0° Efficiency 90 % Peak intensity 0.8 cd/m LEDs/each optic 4 Light colour White Required components: C17528_DAISSY-4X1-SHD-MET</p>		
<p>AUDAX ELECTRONICS</p> <p>LED LIGHT ENGINE DAISY 16 LEDs 156mm x 20mm FWHM / FWTM 64.5° / 92.0° Efficiency 89 % Peak intensity 0.8 cd/m LEDs/each optic 4 Light colour White Required components: C17423_DAISSY-4X1-SHD2-WHT-MATT</p>		
<p>AUDAX ELECTRONICS</p> <p>LED LIGHT ENGINE DAISY 16 LEDs 156mm x 20mm FWHM / FWTM 63.0° / 88.0° Efficiency 77 % Peak intensity 0.8 cd/m LEDs/each optic 4 Light colour White Required components: C17422_DAISSY-4X1-SHD2-MATT</p>		

PHOTOMETRIC DATA (MEASURED):



LED LIGHT ENGINE DAISY 16 LEDs 156mm x 20mm
 FWHM / FWTM 64.5° / 93.0°
 Efficiency 89 %
 Peak intensity 0.8 cd/lm
 LEDs/each optic 4
 Light colour White
 Required components:
 C16784_DAISSY-4X1-SHD-WHT

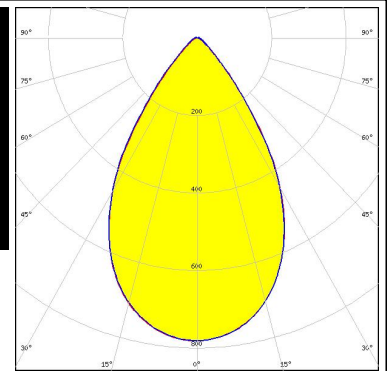

LED LIGHT ENGINE DAISY 16 LEDs 156mm x 20mm
 FWHM / FWTM 63.5° / 88.5°
 Efficiency 78 %
 Peak intensity 0.8 cd/lm
 LEDs/each optic 4
 Light colour White
 Required components:
 C16590_DAISSY-4X1-SHD

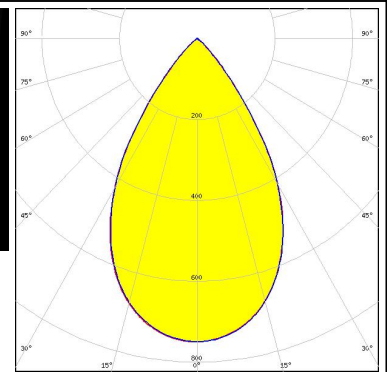

LED LinLED 156x28mm 2x400lm 827-865 2x2C 12V Opt G1
 FWHM / FWTM 64.5° / 92.5 + 92.0°
 Efficiency 87 %
 Peak intensity 0.8 cd/lm
 LEDs/each optic 4
 Light colour Tunable White
 Required components:
 C17535_DAISSY-4X1-SHD2-MET-MATT

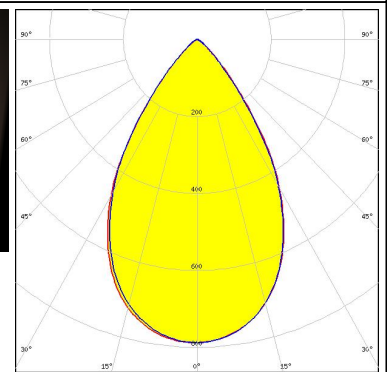
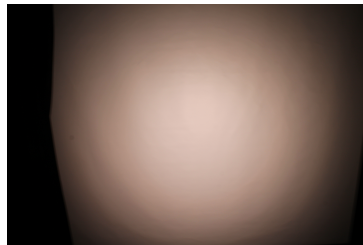

LED LinLED 156x28mm 2x400lm 827-865 2x2C 12V Opt G1
 FWHM / FWTM 65.0 + 64.5° / 91.5 + 91.0°
 Efficiency 89 %
 Peak intensity 0.8 cd/lm
 LEDs/each optic 4
 Light colour Tunable White
 Required components:
 C17528_DAISSY-4X1-SHD-MET

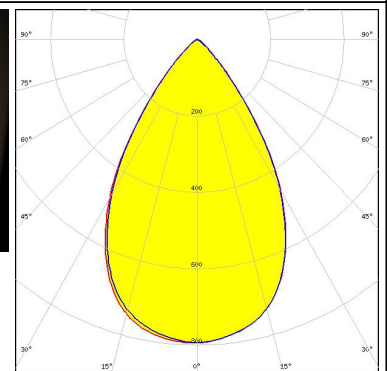
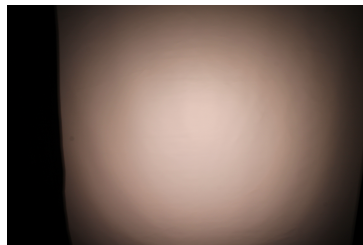

PHOTOMETRIC DATA (MEASURED):

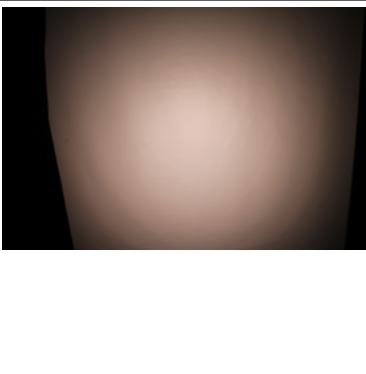
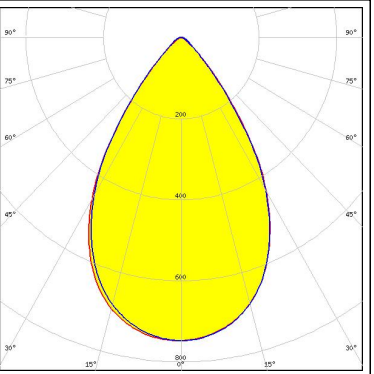
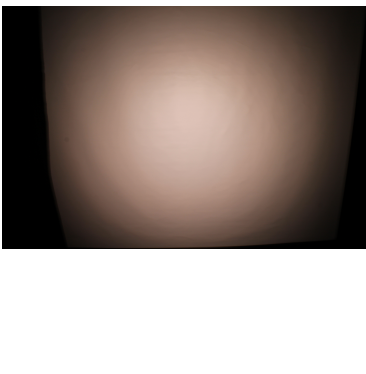
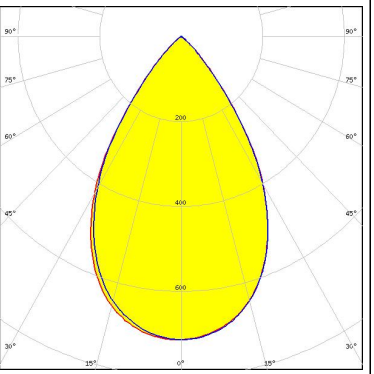
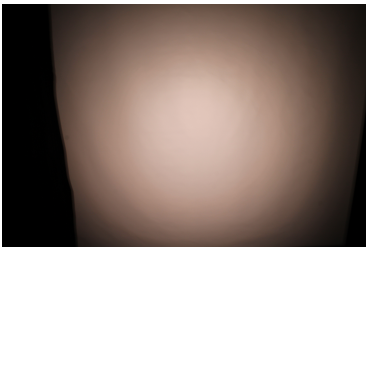
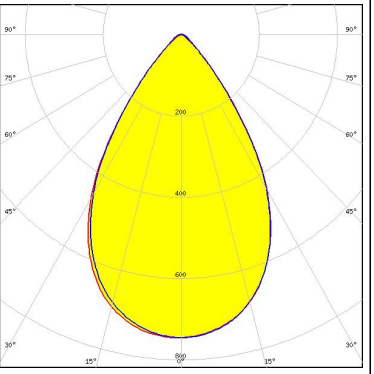
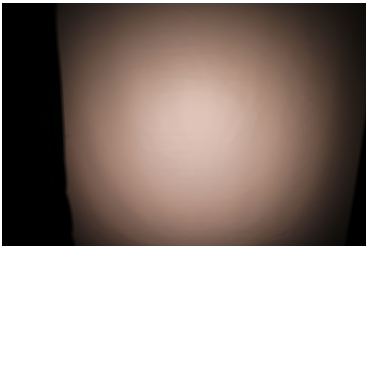
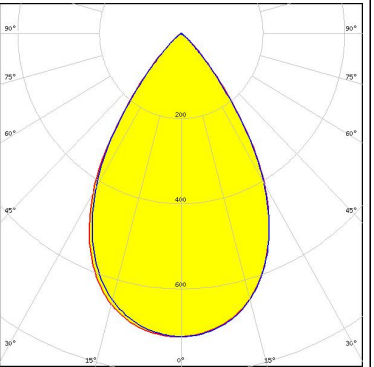
<p>MST <i>Your solutions</i></p> <p>LED LinLED 156x28mm 2x400lm 827-865 2x2C 12V Opt G1 FWHM / FWTM 66.5 + 65.5° / 94.0° Efficiency 89 % Peak intensity 0.7 cd/lm LEDs/each optic 4 Light colour Tunable White Required components: C17423_DAISSY-4X1-SHD2-WHT-MATT</p>		
<p>MST <i>Your solutions</i></p> <p>LED LinLED 156x28mm 2x400lm 827-865 2x2C 12V Opt G1 FWHM / FWTM 64.5° / 90.0 + 89.5° Efficiency 76 % Peak intensity 0.7 cd/lm LEDs/each optic 4 Light colour Tunable White Required components: C17422_DAISSY-4X1-SHD2-MATT</p>		
<p>MST <i>Your solutions</i></p> <p>LED LinLED 156x28mm 2x400lm 827-865 2x2C 12V Opt G1 FWHM / FWTM 66.0 + 65.5° / 94.0° Efficiency 89 % Peak intensity 0.7 cd/lm LEDs/each optic 4 Light colour Tunable White Required components: C16784_DAISSY-4X1-SHD-WHT</p>		
<p>MST <i>Your solutions</i></p> <p>LED LinLED 156x28mm 2x400lm 827-865 2x2C 12V Opt G1 FWHM / FWTM 65.0 + 64.5° / 90.0 + 89.5° Efficiency 77 % Peak intensity 0.7 cd/lm LEDs/each optic 4 Light colour Tunable White Required components: C16590_DAISSY-4X1-SHD</p>		

PHOTOMETRIC DATA (MEASURED):

MST

Your solutions

LED LinLED 156x28mm 800lm 8x0 2C 12V Opt G1
 FWHM / FWTM 64.0° / 91.0 + 90.5°
 Efficiency 88 %
 Peak intensity 0.8 cd/lm
 LEDs/each optic 4
 Light colour White
 Required components:
 C17528_DAISSY-4X1-SHD-MET

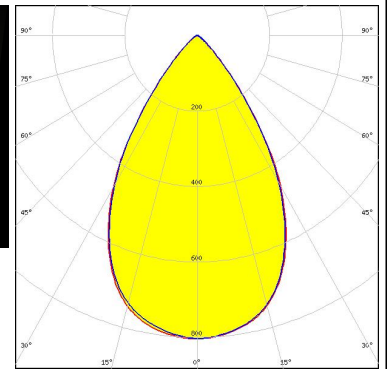
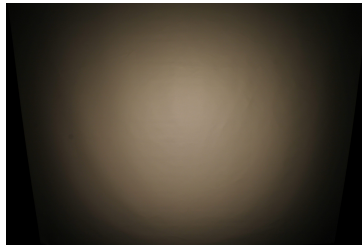

MST

Your solutions

LED LinLED 156x28mm 800lm 8x0 2C 12V Opt G1
 FWHM / FWTM 65.0° / 93.0°
 Efficiency 88 %
 Peak intensity 0.8 cd/lm
 LEDs/each optic 4
 Light colour White
 Required components:
 C17423_DAISSY-4X1-SHD2-WHT-MATT

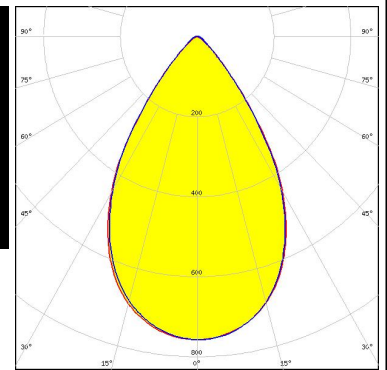
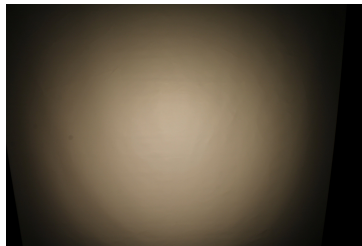

MST

Your solutions

LED LinLED 156x28mm 800lm 8x0 2C 12V Opt G1
 FWHM / FWTM 64.0 + 63.5° / 89.5 + 89.0°
 Efficiency 76 %
 Peak intensity 0.7 cd/lm
 LEDs/each optic 4
 Light colour White
 Required components:
 C17422_DAISSY-4X1-SHD2-MATT

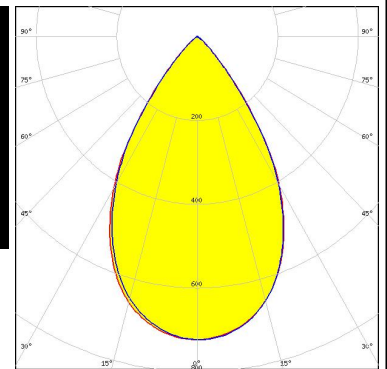
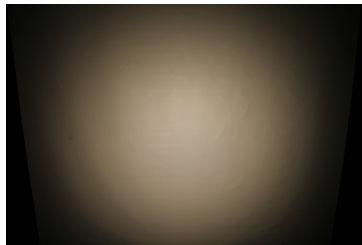

MST

Your solutions

LED LinLED 156x28mm 800lm 8x0 2C 12V Opt G1
 FWHM / FWTM 65.5 + 65.0° / 93.0 + 93.5°
 Efficiency 88 %
 Peak intensity 0.8 cd/lm
 LEDs/each optic 4
 Light colour White
 Required components:
 C16784_DAISSY-4X1-SHD-WHT

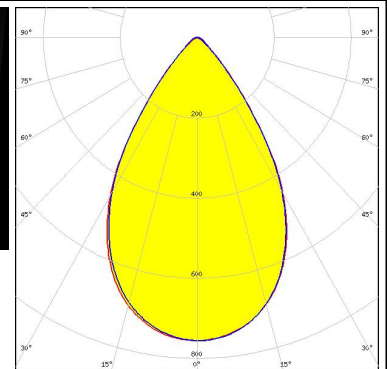
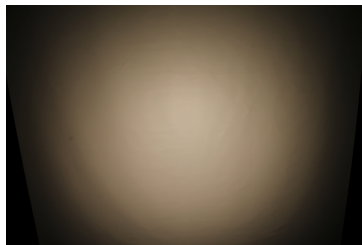

PHOTOMETRIC DATA (MEASURED):

MST *Your solutions*

LED LinLED 156x28mm 800lm 8x0 2C 12V Opt G1
 FWHM / FWTM 64.0° / 89.0 + 88.5°
 Efficiency 77 %
 Peak intensity 0.7 cd/lm
 LEDs/each optic 4
 Light colour White
 Required components:
 C16590_DAISSY-4X1-SHD

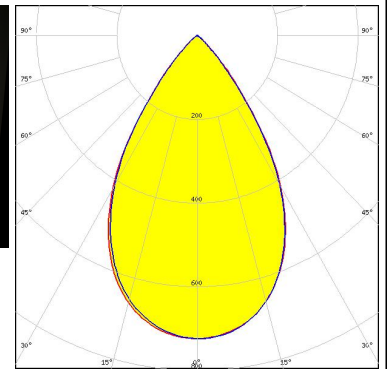

MST *Your solutions*

LED LinLED 156x28mm 800lm 8x0 2C 12V Opt G1
 FWHM / FWTM 64.0° / 92.0°
 Efficiency 87 %
 Peak intensity 0.8 cd/lm
 LEDs/each optic 4
 Light colour White
 Required components:
 C17535_DAISSY-4X1-SHD2-MET-MATT

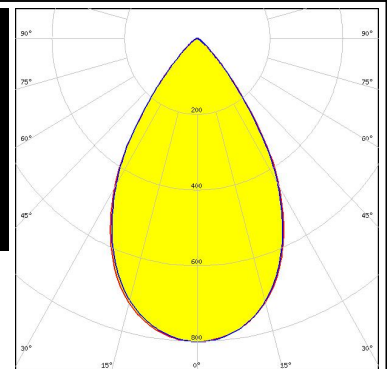
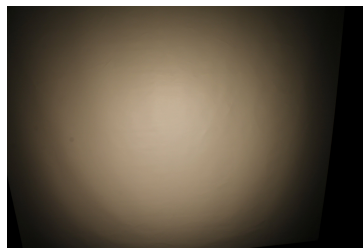

NICHIA

LED NF2W757G-MT (Tunable White)
 FWHM / FWTM 60.0° / 84.0°
 Efficiency 82 %
 Peak intensity 0.9 cd/lm
 LEDs/each optic 1
 Light colour Tunable White
 Required components:
 C16590_DAISSY-4X1-SHD

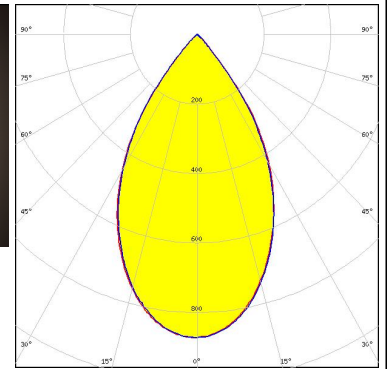
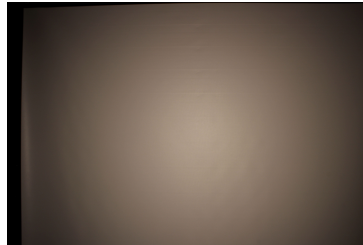

NICHIA

LED NF2W757G-MT (Tunable White)
 FWHM / FWTM 61.0° / 86.0°
 Efficiency 93 %
 Peak intensity 0.9 cd/lm
 LEDs/each optic 1
 Light colour Tunable White
 Required components:
 C16784_DAISSY-4X1-SHD-WHT

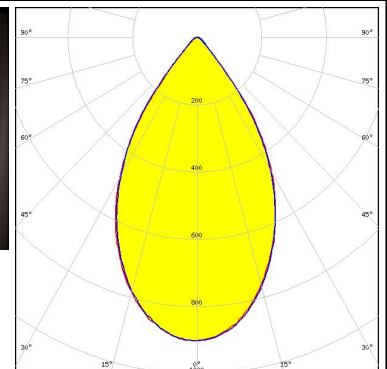
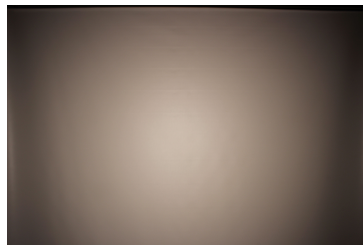

PHOTOMETRIC DATA (MEASURED):

SAMSUNG

LED LM28xB Series
 FWHM / FWTM 62.0° / 87.0°
 Efficiency 92 %
 Peak intensity 0.9 cd/lm
 LEDs/each optic 1
 Light colour White
 Required components:
 C16784_DAISSY-4X1-SHD-WHT

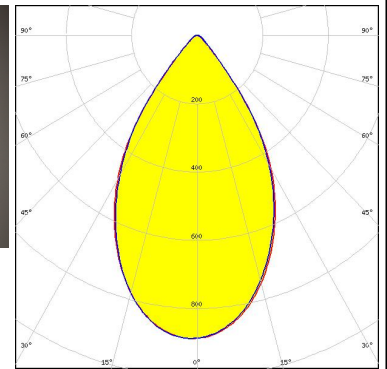
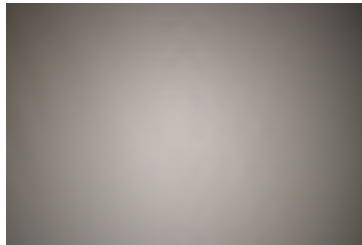

SAMSUNG

LED LM28xB Series
 FWHM / FWTM 61.0° / 85.0°
 Efficiency 82 %
 Peak intensity 0.9 cd/lm
 LEDs/each optic 1
 Light colour White
 Required components:
 C16590_DAISSY-4X1-SHD

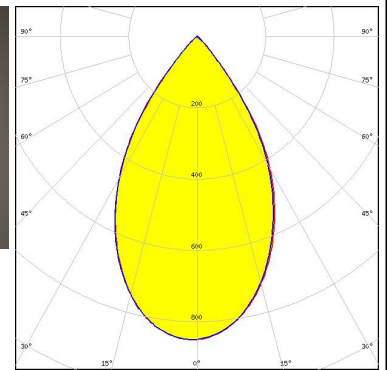
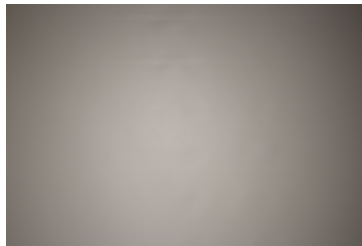

SAMSUNG



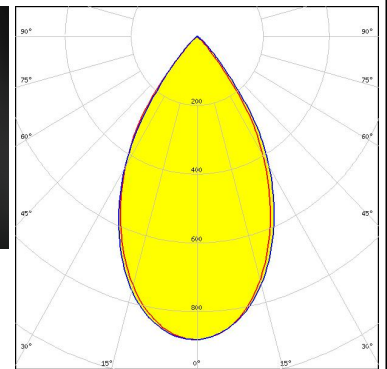
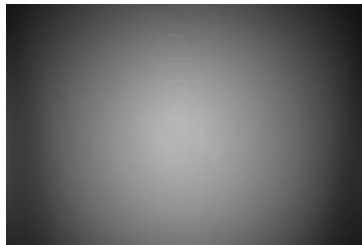

LED LM28xB Series
 FWHM / FWTM 59.0° / 85.0°
 Efficiency 81 %
 Peak intensity 0.9 cd/lm
 LEDs/each optic 1
 Light colour White
 Required components:
 C17422_DAISSY-4X1-SHD2-MATT

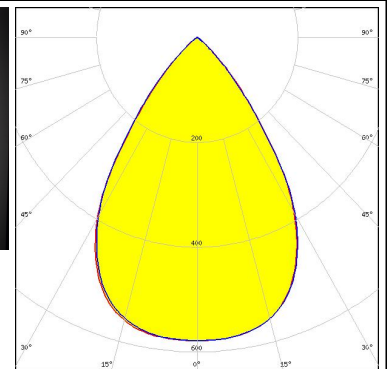
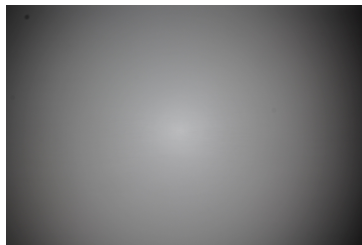

LED PassivePAQ-L-0.5F35-SSA3-1.6K-840-3-DC
 FWHM / FWTM 69.0° / 93.0°
 Efficiency 72 %
 Peak intensity 0.6 cd/lm
 LEDs/each optic 4
 Light colour White
 Required components:
 C16590_DAISSY-4X1-SHD

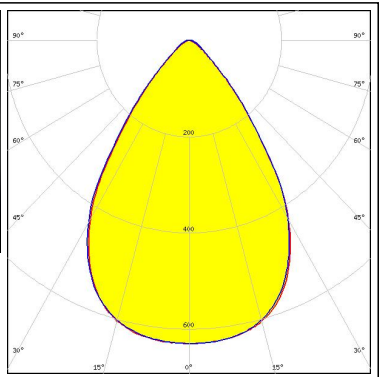

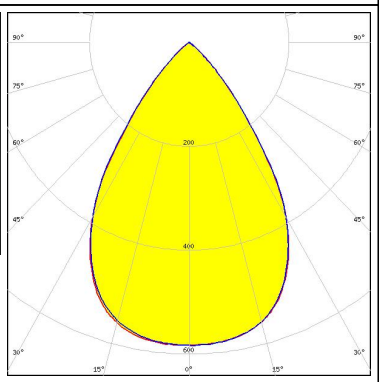
PHOTOMETRIC DATA (MEASURED):

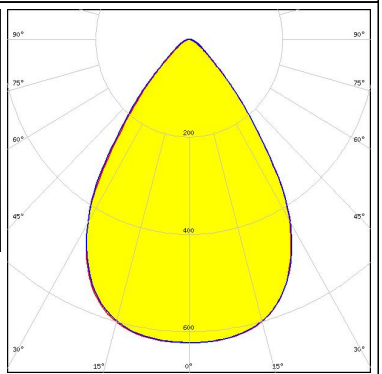
<p>TEPCOMP group</p> <p>LED PassivePAQ-L-0.5F35-SSA3-1.6K-840-3-DC</p> <p>FWHM / FWTM 70.0° / 100.0°</p> <p>Efficiency 88 %</p> <p>Peak intensity 0.6 cd/lm</p> <p>LEDs/each optic 4</p> <p>Light colour White</p> <p>Required components: C17423_DAISSY-4X1-SHD2-WHT-MATT</p>		
<p>TEPCOMP group</p> <p>LED PassivePAQ-L-0.5F35-SSA3-1.6K-840-3-DC</p> <p>FWHM / FWTM 69.0° / 93.0°</p> <p>Efficiency 71 %</p> <p>Peak intensity 0.6 cd/lm</p> <p>LEDs/each optic 4</p> <p>Light colour White</p> <p>Required components: C17422_DAISSY-4X1-SHD2-MATT</p>		
<p>TEPCOMP group</p> <p>LED PassivePAQ-L-0.5F35-SSA3-1.6K-840-3-DC</p> <p>FWHM / FWTM 70.0° / 100.0°</p> <p>Efficiency 87 %</p> <p>Peak intensity 0.6 cd/lm</p> <p>LEDs/each optic 4</p> <p>Light colour White</p> <p>Required components: C16784_DAISSY-4X1-SHD-WHT</p>		

GENERAL INFORMATION:

NOTE: The typical beam angle will be changed by different color, chip size and chip position tolerance. The typical total beam angle is the full angle measured where the luminous intensity is half of the peak value.

MATERIALS:

As part of our continuous research and improvement processes, and to ensure the best possible quality and availability of our products, LEDiL reserves the right to change material grades without notice.

PRODUCT DATA USER AGREEMENT AND DISCLAIMER:

The measured data in the provided downloadable LEDiL Product Datasheets and Mechanical 2D-Drawings is rounded and provided as reference for planning. LEDiL Oy's optical specifications have been verified by conducting performance testing of the products in accordance with the company's quality system. The reported data are averaged results of multiple measurements with typical variation. LEDiL Oy reserves the right to without prior notification make changes and improvements to its products.

LEDiL Oy assumes neither warranty, nor guarantee nor any other liability of any kind for the contents and correctness of the provided data. The provided data has been generated with highest diligence but the provided data may in reality not represent the complete possible variation range of all intrinsic parameters. Therefore, in certain cases a deviation from the provided data could occur.

LEDiL Oy reserves the right to undertake technical changes of its products without further notification which could lead to changes in the provided data. LEDiL Oy assumes no liability of any kind for the possible deviation from any provided data or any other damage resulting from the usage of the provided data.

The user agrees to this disclaimer and user agreement with the download or usage of the provided files.

LEDiL Oy

Joensuunkatu 13
FI-24240 SALO
Finland

LEDiL Inc.

228 West Page Street
Suite D
Sycamore IL 60178
USA

Ledil Optics Technology (Shenzhen) Co., Ltd.

405 , Block B
Casic Motor Building
Shenzhen 518057
P.R.CHINA

Local sales and technical support

[www.ledil.com/
where_to_buy](http://www.ledil.com/where_to_buy)

Shipping locations

Salo, Finland
Hong Kong, China

Distribution Partners

[www.ledil.com/
where_to_buy](http://www.ledil.com/where_to_buy)